	Technical Guide		TG-19-C-034-E	C
	Produced by: pelrom	Date: 15.01.2009	3	Modifications: See last page

CALIBRE 2403

	Version A	Version B
$11\frac{1}{2}''$ Ø 25,60 mm		
Height on movement	4.10 mm	
Power reserve	44 h	48 h
Number of jewels	27	27
Frequency	4 Hz (28'800 A/h)	3.5 Hz (25'200 A/h)
Lift angle	30° / 38°	38°

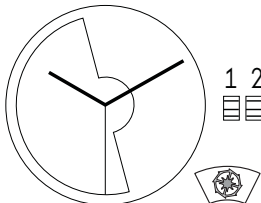
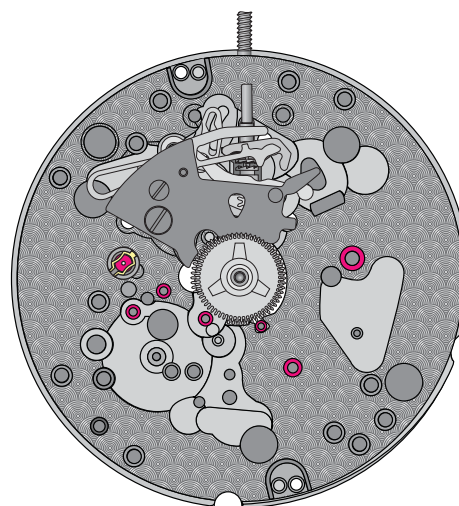

Automatic movement, Co-Axial escapement, COSC-certified,
Omega balance system without index. Hour, minute and second hands in centre.

	Page
Calibre 2403	1
General information for Calibre 2403	3-4
Date correction / Measure Instruments / Complete balance bridge	3
Tightening torques / Hand fitting / Tools / Lubricants	3
Improvements on version B / Technical modifications on version «B»	4
Differences between the versions for Calibre 2403	5-6
Differences between the versions	5-6
Exploded views for Calibre 2403	7-10
Dial side	7
Movement side	8
Movement side	9
Dial side	10
Spare parts list for Calibre 2403	11-13
Spare parts list	11
Spare parts list	12
Spare parts list	13
Specific information for Calibre 2403	14-16
Assembling of the escapement system	14
Assembling of the balance bridge / Disassembling of the balance bridge	14
Runners for hand setting and hand setting force /	15
Components not requiring epilam coating	15
Timing key	16
Modifications of Technical Guide for Calibre 2403	17

General information for Calibre 2403

Date correction

Date correction should not be performed between 10 pm and 2 am.

Co-Axial Escapement lubricants

See Working Instruction No 40.

Tightening and untightening torques according to screw thread size

Intervention	Required minimum equipment	Comments
Complete or Partial maintenance service Co-Axial 3.5 Hz & 4 Hz	- Watch Expert II (white case) - Chronoscope M1 (up-dated version) - Chronoscope S1	
Rate adjustment on a new watch: (Co-Axial 3.5 Hz & 4 Hz)	- Watch Expert (red case) - Wicometer Professional - Chronoscope M1 (old version)	Important: The amplitude will not be correctly indicated. For rate adjustment only, this can be accepted!

Complete balance bridge (Ref. 10.058°)

The balance bridge is not available.
(see CS-Info Calibre No 33).

Tightening and untightening torques according to screw thread size

Ø Screw	Tightening torque target cNm	Untightening torque mini cNm
Ø threads ≤ S 0.50 mm	1.0	0.7
Ø threads S 0.6 mm	1.4	0.8
Ø threads S 0.7 mm	1.8	0.9
Ø threads S 0.8 mm	2.2	1.1
Ø threads S 0.9 mm	2.6	1.3
Ø threads S 1.0 mm	3.0	1.6
Ø threads S 1.2 mm	3.5	2.0
Ø threads S 1.4 et >	4.0	2.5

Hand fitting

To fit the hands, the movement must be placed in a suitable, well-adjusted movement holder.

Tools

Hand fitting tool kit	Reference 507 0011
Movement holder for hand fitting	507 0017
Mainspring winder	502 150 0009
Timing key	506 0042
Tool for checking the escapement functions	506 0002
Ball bearing set	502 S03 SET
Key-bolt key for oscillating weight	502 200 0361
Holder for oscillating weight	502 100 0381

Lubricants



Moebius SYNT-A-LUBE 9010 (2ml)	Reference 504 200 0001
Moebius HP-500	504 5012
Moebius SYNT HP-1300 Sans Colorant	504 5013
Moebius 9504	504 5014
Kluber P125	504 100 0071
Lubeta V105	504 5005

General information for Calibre 2403











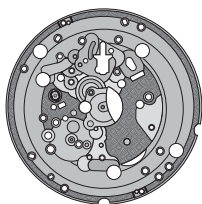
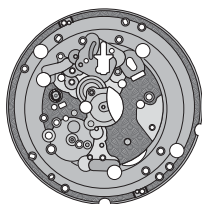

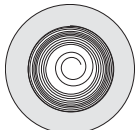
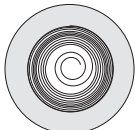
Improvements on version B

Version A	Version B
Quality of adjustment: Good	Quality of adjustment: Improved
Self-starting: Medium	Self-starting: Good















Technical modifications on version «B»

Intermediate escape wheel				
Old version	Risk	New version	Improvements	Notes
7222500C30039		7222500C30039		
	Black residues within the engagement can cause low amplitude or a stop of the watch. The old version is yellow.		Improvement of surface and material. The new version is grey. Available since 33/2008.	The new version must automatically be assembled if black residues within the engagement are visible.

Differences between version 2403A and 2403B

	2403A (4 Hz)	2403B (3.5 Hz)
Mainplate	 ref. 7222403A1002007 Engraving 2403A	 ref. 7222403B1002007 Engraving 2403B
Barrel, complete	 ref. 7222500B20010	 ref. 722112020010
Mainspring	 ref. 7222500B20102	 ref. 722112020102
Second wheel	 ref. 722112030027* 96 teeth and eight arms	 ref. 7222500C30027* 105 teeth and five arms
Intermediate escape wheel	 ref. 7222500B30039 8-leaf pinion	 ref. 7222500C30039 10-leaf pinion Cutout in upper pivot shank
Co-Axial wheel	 ref. 7222500B30040 Pinion $\varnothing = 1.999$ mm	 ref. 7222500C30040 Pinion $\varnothing = 2.119$ mm
Pallet fork	 Old shape ref. 7222500B40010	 New shape ref. 7222500C40010
Balance complete with stud	 ref. 7222500B4005021 7.2 (mgcm ²) 8.54 mm 0.37 mm \varnothing 0.08 mm cylindrical 0.09 mm = pivot hole \varnothing	 ref. 7222500C4005021 9.4 (mgcm ²) 8.70 mm 0.45 mm \varnothing 0.07 mm conical 0.08 mm = pivot hole \varnothing
Inertia		
Diameter		
Balance rim thickness		
Pivots		
shock absorber		
Rate correction with 1 screw-revolution (on both screws)	57 seconds	86 seconds



Differences between version 2403A and 2403B

	2403A (4Hz)	2403B (3.5 Hz)
Stop lever	 ref. 7222500B56070	 ref. 7222500C56070
Jewelled shock-absorber, upper	  ref. 722112070530	  ref. 7222500C70530
Jewelled shock-absorber, lower	  ref. 722112070531	  ref. 7222500C70531
In settings, upper	 ref. 722112070640	 ref. 7222500C70640
In settings, lower	 ref. 722112070641	 ref. 7222500C70641

Exploded views - Dial side for Calibre 2403

Parts listed in order of assembly

1 = 1002007	8 = 51091
2 = 31120	9 = 3503 (1x)
3 = 311211	10 = 31083*
4 = 5101021	11 = 31041
5 = 53022	12 = 31100
6 = 5108006	13 = 10062
7 = 51050	14 = 3503 (1x)

	Moebius SYNT HP-1300 Sans Colorant
	Moebius SYNT HP-1300 Sans Colorant
	Moebius 9504

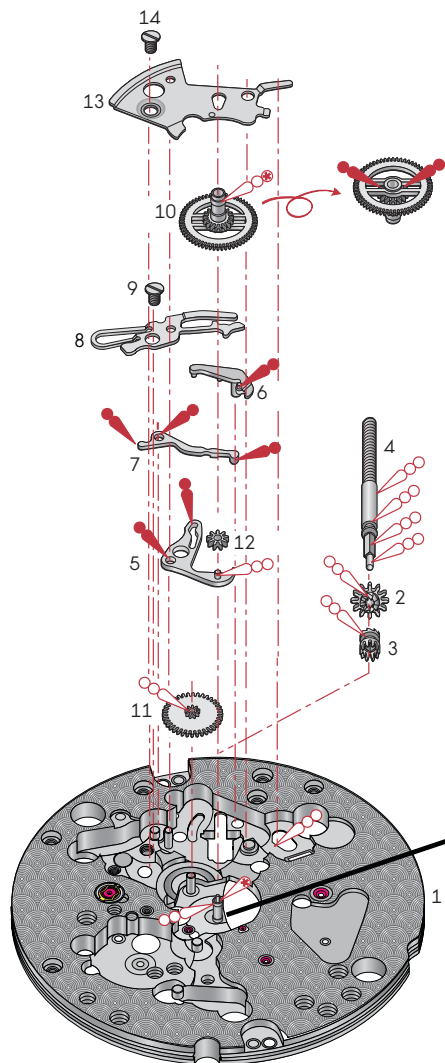

Additional lubrication:
See CS-Info Calibre no. 32



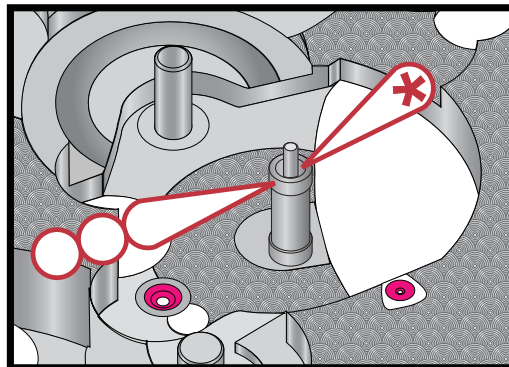

Lubrication spot (Moebius 9010, small quantity)
at the exit of the second wheel axle - centre tube.



Exploded views - Movement side for Calibre 2403

Parts listed in order of assembly

1 = 1004107	14 = 30039
2 = 32033	15 = 30025
3 = 31023	16 = 30027*
4 = 31024	17 = 1004807
5 = 31021	18 = 3505 (1x)
6 = 51120	19 = 30040
7 = 81036	20 = 40010
8 = 3509 (1x)	21 = 1005707
9 = 30012	22 = 3511 (1x)
10 = 20010	23 = 3511 (1x)
11 = 31020	24 = 10058°
12 = 1004107	4005021
13 = 3503 (3x)	25 = 3503 (1x)

-  Moebius SYNT-A-LUBE 9010
-  Moebius SYNT HP-1300 Sans Colorant
-  Moebius SYNT HP-500
-  Moebius SYNT HP-1300 Sans Colorant
-  Kluber P125

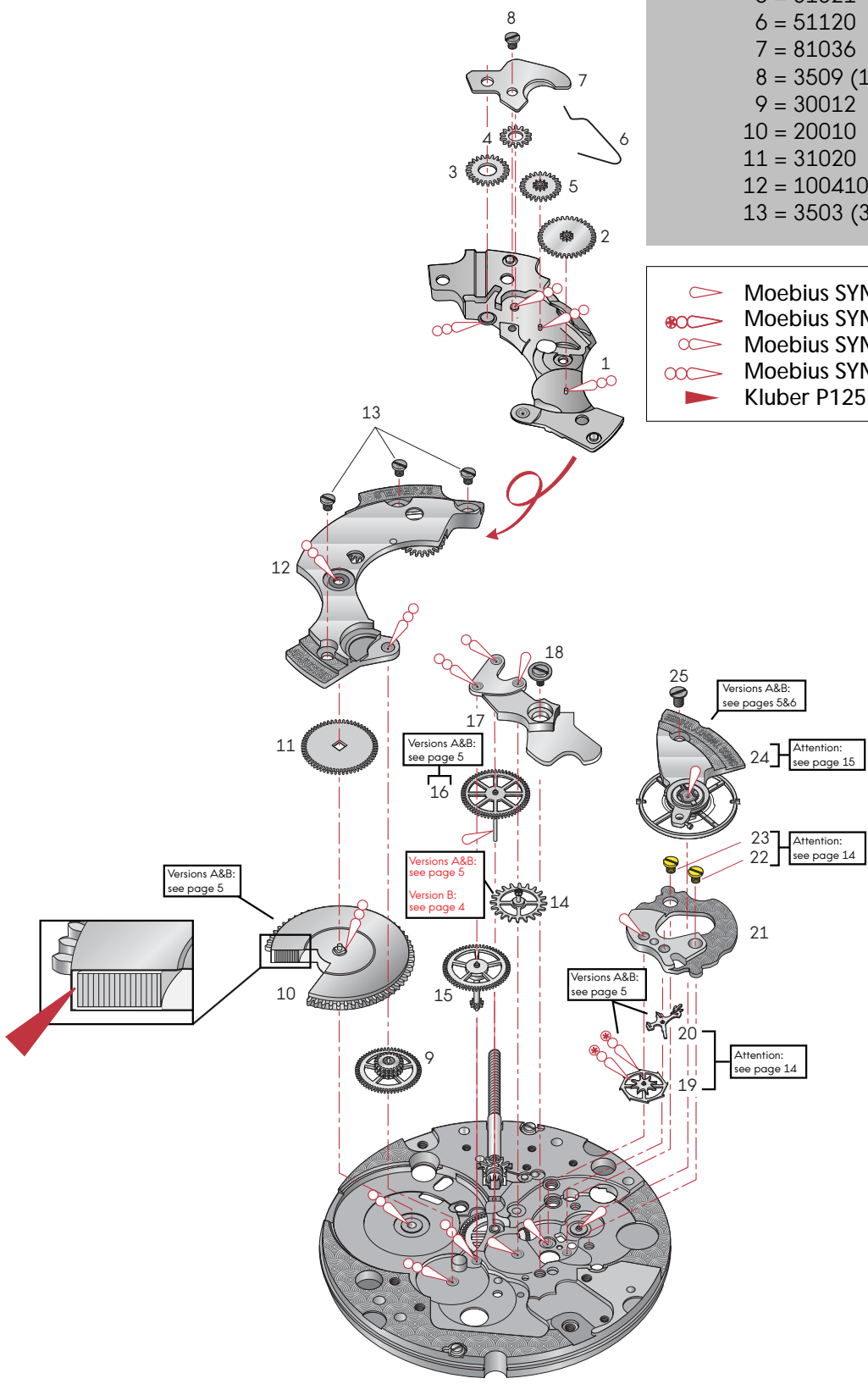

Exploded views - Movement side for Calibre 2403

Parts listed in order of assembly

1 = 56070	8 = 3504 (1x)
2 = 1203007	9 = 2201006
3 = 32032	10 = 3507 (3x)
4 = 32031	11 = 3503 (3x)
5 = 32037	12 = 52041
6 = 52040	13 = 12124
7 = 1205107	14 = 3506 (1x)

⚠ See CS-Info Calibre no. 26 Lubeta V105
When Lubeta V105 is available, do not use Moebius 9010

⚙ Moebius SYNT-A-LUBE 9010
⊖ Moebius SYNT HP-1300 Sans Colorant

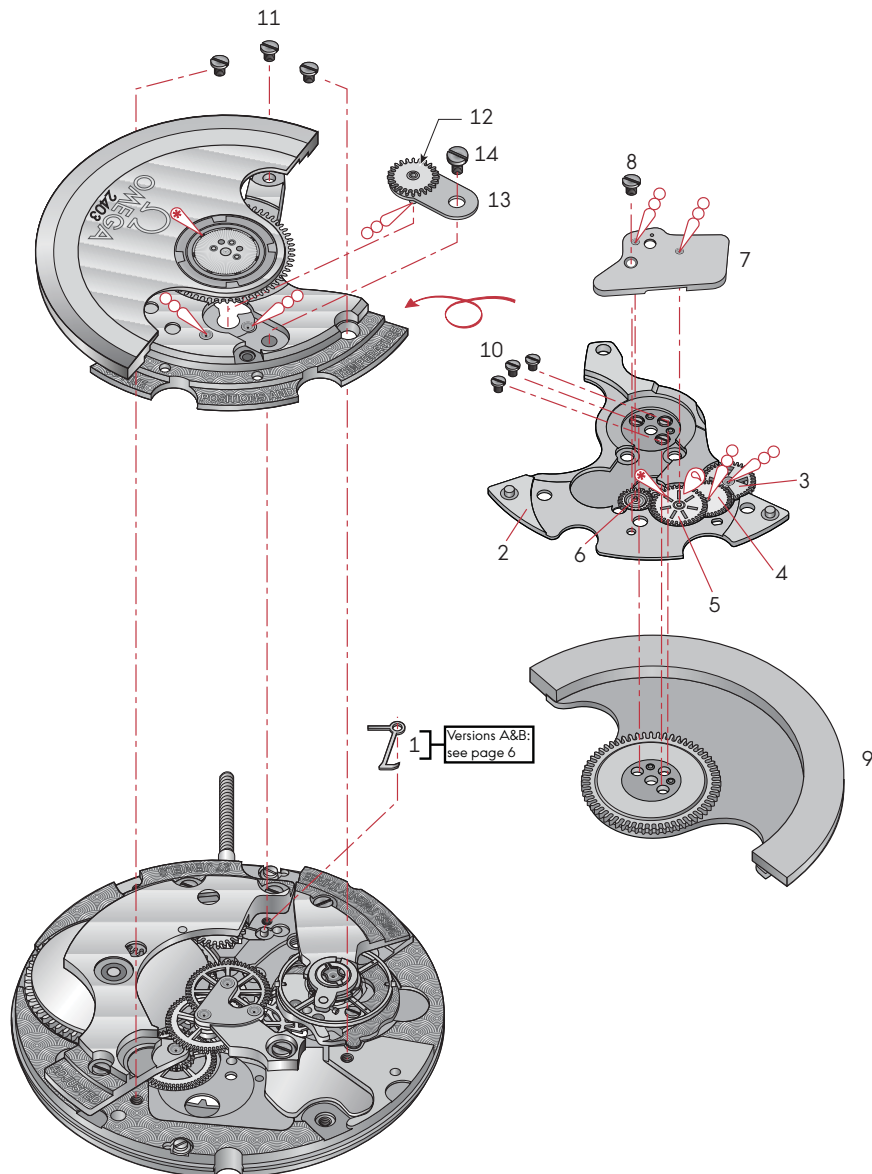

Exploded views - Dial side for Calibre 2403

Parts listed in order of assembly







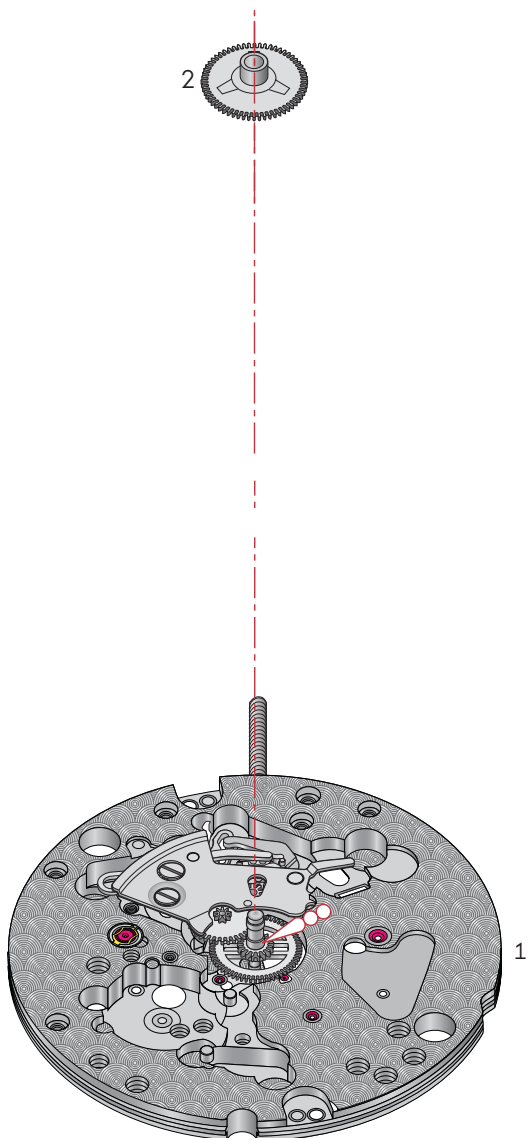



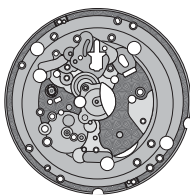

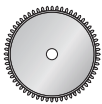



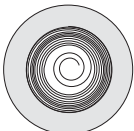

1 = 1002007

2 = 31046*

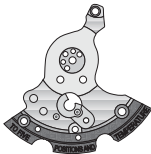

























 Moebius SYNT HP-1300 Sans Colorant



Spare parts list for Calibre 2403

Main plate, pre-assembled	Version	Reference	Barrel complete	Version	Reference
	2403A	7222403A1002007		2403A	7222500B20010
	2403B	7222403B1002007		2403B	722112020010
Barrel bridge	Version	Reference	Barrel, drum and cover	Version	Reference
	2403A	7222500B1004107		2403A	722112020030
	2403B			2403B	
Wheel train bridge	Version	Reference	Barrel arbor	Version	Reference
	2403A	7222500B1004807		2403A	722112020060
	2403B			2403B	
Pallet bridge, pre-assembled	Version	Reference	Mainspring	Version	Reference
	2403A	72225001005707		2403A	7222500B20102
	2403B			2403B	722112020102
Balance bridge, pre-assembled	Version	Reference	Oscillating weight	Version	Reference
	2403A	7222500B1005824		2403A	7222403A2201006
	2403B	7222500C1005824		2403B	
Minute wheel train bridge	Version	Reference	Ball bearing	Version	Reference
	2403A	722112010062		2403A	722112022040
	2403B			2403B	
Dial fastener	Version	Reference	Oscillating weight bolt	Version	Reference
	2403A	722112010300		2403A	722112022042
	2403B			2403B	
Upper automatic bridge	Version	Reference	Intermediate wheel	Version	Reference
	2403A	7222500B1203007		2403A	722112030012
	2403B			2403B	
Lower automatic bridge	Version	Reference	Third wheel	Version	Reference
	2403A	72211201205107		2403A	722112030025
	2403B			2403B	
Reverser maintaining plate	Version	Reference	Second wheel	Version	Reference
	2403A	722112012124		2403A	722112030027*
	2403B			2403B	7222500C30027*

Spare parts list for Calibre 2403

Intermediate escape wheel	Version	Reference	Intermediate reduction wheel	Version	Reference
	2403A	7222500B30039		2403A	722112032032
	2403B	7222500C30039		2403B	
Co-Axial wheel	Version	Reference	Ratchet wheel driving wheel	Version	Reference
	2403A	7222500B30040		2403A	722112032033
	2403B	7222500C30040		2403B	
Ratchet wheel	Version	Reference	Reversing wheel	Version	Reference
	2403A	722112031020		2403A	722112032037
	2403B			2403B	
Intermediate ratchet wheel	Version	Reference	Pallet fork	Version	Reference
	2403A	722112031021		2403A	7222500B40010
	2403B			2403B	7222500C40010
Crown wheel	Version	Reference	Balance complete with stud	Version	Reference
	2403A	722112031023		2403A	7222500B4005021
	2403B			2403B	7222500C4005021
Intermediate crown wheel	Version	Reference	Stud support	Version	Reference
	2403A	722112031024		2403A	7222500B40200
	2403B			2403B	
Minute wheel	Version	Reference	Winding stem	Version	Reference
	2403A	722112031041*		2403A	72211205101021
	2403B			2403B	
Hour wheel	Version	Reference	Yoke	Version	Reference
	2403A	722112031046*		2403A	722112051050
	2403B			2403B	
Cannon pinion with driving wheel	Version	Reference	Setting lever	Version	Reference
	2403A	722112031083*		2403A	72211205108006
	2403B			2403B	
Setting wheel	Version	Reference	Setting lever jumper	Version	Reference
	2403A	722112031100		2403A	7222200A51091
	2403B			2403B	
Winding pinion	Version	Reference	Click	Version	Reference
	2403A	722112031120		2403A	722112051120
	2403B			2403B	
Sliding pinion	Version	Reference	Reverser	Version	Reference
	2403A	7221120311211		2403A	722112052040
	2403B			2403B	
Reduction wheel	Version	Reference	Auxiliary reverser	Version	Reference
	2403A	722112032031		2403A	722112052041
	2403B			2403B	

Spare parts list for Calibre 2403

























Date corrector operating lever	Version	Reference	Screw for automatic device	Version	Reference
	2403A	722112053022		2403A	72211203503
	2403B			2403B	
Stop lever	Version	Reference	Screw for barrel bridge	Version	Reference
	2403A	7222500B5607		2403A	72211203503
	2403B	7222500C56070		2403B	
Shock-absorber, upper	Version	Reference	Screw for balance bridge	Version	Reference
	2403A	722112070530		2403A	72211203503
	2403B	7222500C70530		2403B	
Shock-absorber, lower	Version	Reference	Screw for lower automatic device bridge	Version	Reference
	2403A	722112070531		2403A	72211203504
	2403B	7222500C70531		2403B	
In settings, upper	Version	Reference	Screw for wheel train bridge	Version	Reference
	2403A	722112070640		2403A	72211203505
	2403B	7222500C70640		2403B	
In settings, lower	Version	Reference	Reverser maintaining plate screw	Version	Reference
	2403A	722112070641		2403A	72211203506
	2403B	7222500C70641		2403B	
Cap jewel, upper	Version	Reference	Ball bearing screw	Version	Reference
	2403A	722112070900		2403A	72211203507
	2403B			2403B	
Cap jewel, lower	Version	Reference	Screw for click plate	Version	Reference
	2403A	722112070901		2403A	72211203509
	2403B			2403B	
Shock-absorber spring, upper	Version	Reference	Screw for pallet bridge	Version	Reference
	2403A	722112078004		2403A	72225003511
	2403B			2403B	
Shock-absorber spring, lower	Version	Reference	Screw for stud	Version	Reference
	2403A	722112078005		2403A	72225003512
	2403B			2403B	
Centre tube	Version	Reference			
	2403A	722112080400			
	2403B				
Click plate	Version	Reference			
	2403A	722112081036			
	2403B				
Screw for setting lever jumper	Version	Reference			
	2403A	72211203503			
	2403B				
Screw for minute wheel train bridge	Version	Reference			
	2403A	72211203503			
	2403B				

Fig. 1.0



1.0 Assembling of the escapement system

Key points

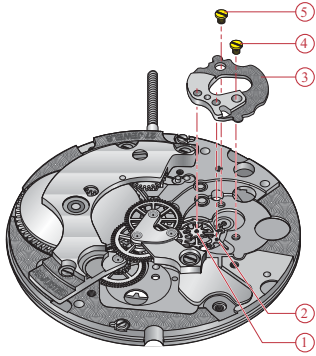
The order of assembly must be respected (See page 11). After assembling, the escapement functions must be checked accurately with the corresponding tool.

The pallet bridge positions the co-axial wheel and the pallet fork. To ensure the functioning of the escapement it is necessary to respect the following order of assembly:

1. Position the co-axial wheel.
2. Position the pallet fork.
3. Position the pallet bridge, screw no (4) must be correctly placed in their beds.
4. To position the pallet bridge, screw no (4) must be fixed first.
5. The second screw (5) fixes the bridge.

Fig. 2.0

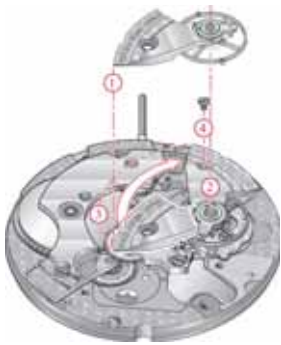

2.0 Assembling of the balance bridge

As the table roller is under the pallet fork, the balance must be assembled carefully.

1. Position the complete balance bridge (with balance). The bridge is pointing towards the center of the movement.
2. Check the position of the balance. The pivot of the balance-staff must be correctly placed in its bed.
3. Carefully turn the bridge to its normal position.
4. Fix the bridge with its screw.

Fig. 2.1













2.1 Disassembling of the balance bridge

The balance bridge must be disassembled by removing the parts in the opposite order of procedure 2.0. To avoid any risk of damaging the balance, the bridge has to be turned towards the center of the movement. In this position the bridge may be removed without any risk.

3.0 Runners for hand setting and hand setting force

Description	Movement holder	Nbr. of hand setting runners	Minimum force (N)	Maximum force (N)	Support (jewels)
Hour hand	507 0017	5	10	50	no
Minute hand		2	10	50	no
Second hand		1	10	30	yes

4.0 Components that must not be epilam-treated after cleaning

Description	Reference	
Balance assembled on the balance bridge *	40055 + 10058°	
Complete balance	40055	
Pallet fork	40010	
In-setting, upper *	70640	
In-setting, lower *	70641	
Pallet fork bridge	1005707	
Barrel **	20010	
Mainspring	20102	
Reversing wheel	32037	 

* Do not treat the shock-absorber settings with epilam; the cap jewels should however be treated

** Do not treat the complete barrel with epilam, only the drum, cover and arbour separately.

Demagnetise the movement according to Working Instruction 34.

Values to be checked

Please consult Working Instructions 5 and 28 for instructions and tolerances.

Special parameter settings

Instrument type	Co-Axial 4 Hz calibres	Co-Axial 3.5 Hz calibres	Comments
Former Witschi instruments - Watch Expert (red case) - Wicometer Professionnel - Chronoscope M1 (old version)	Lift angle set to 30°	Lift angle set to 38°	3.5 Hz calibres: The frequency parameters (25'200 A/h) should be set manually so that the instantaneous rate is
	All measurements are correct	The amplitude is not measured correctly	
New Witschi instruments - Watch Expert II (white case) - Chronoscope M1 (up-dated version) - Chronoscope S1	Lift angle set to 38°	Lift angle set to 38°	Test mode: Parameters must be set for «Spe1»!
	All measurements are correct	All measurements are correct	

Fig. 5.0

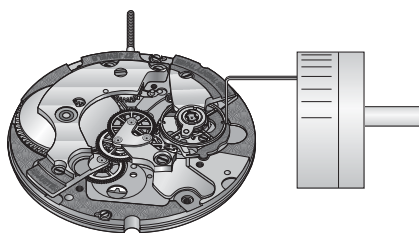
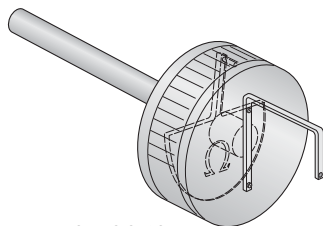
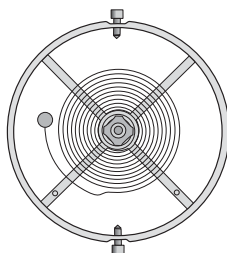

Fig. 5.1



REF. 506 0042

Fig. 5.2



5.0 Timing key

A special timing key tool has been developed to adjust the rate even when the movement is cased in. The rate can be corrected according to the table below by turning the two balance screws a complete turn. A scale is found on the outside of the tool. A division corresponds to a rate correction of 1 second. (according to the table below). One screw is located between two arms on the balance which are specially marked by points (see Figure 5.2) for easy identification of each screw during the correction process.

Balance

The annular balance has two adjusting micro-screws. A slow rate deviation is corrected by tightening the micro-screws (towards the centre of the balance), which reduces its moment of inertia and makes it run faster. A fast rate deviation is corrected by loosening the micro-screws (away from the centre of the balance). This increases its moment of inertia and makes it run slower.

Important:

The rate is always corrected using **both** adjustment screws to prevent an unbalance of the balance.

Version A	Version B
One correction turn = 57 seconds	One correction turn = 86 seconds
One division = 1 second	One division = 1.5 seconds

Modifications of Technical Guide for Calibre 2403

Technical Guide versions			
Date of first edition:	01.04.2008	Version A	Made by:
Date of second edition:	12.09.2008	Version B	
Date of last edition:	15.01.2009	Version C	
			Pelrom
			Rendav
			Pelrom

Modifications of Technical Guide version B	
Old (version A)	New (version B)
	All the information's that are mentioned in red have been modified or updated.

Modifications of Technical Guide version C
New (version C)
All the information's that are mentioned in red have been modified or updated.